



Above glass awning

markilux 770 tracfix

The clean and concise exterior awning for medium-sized areas.



reddot design award
winner 2017



GERMAN
DESIGN
AWARD
WINNER
2018

markilux
safe timeless beautiful

Product Characteristics

Wind resistance class 3
Beaufort 6 → 38–48 km/h → 10.5–13.4 m/s → 24–30 mph

01
02
03
04
05
06
07
08
09
10
11
12
13
14
15
16
17
18
19



1 side view track-only fixture

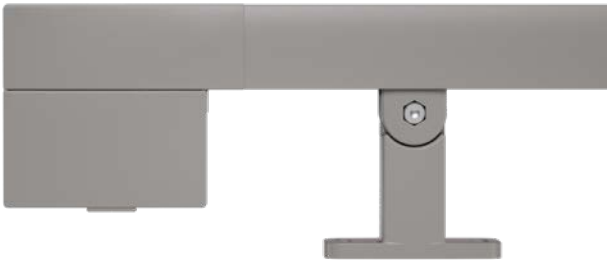

2 when extended, the front profile finishes flush with the end of the guide tracks

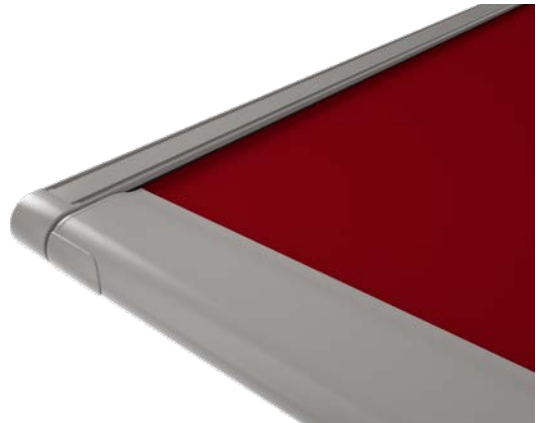

3 tracfix cover guidance system – leaves no gap between the cover and the guide track



Product Characteristics

Description

- exterior awning for conservatories and glass canopies. One awning can shade an area of up to 18 m²

Special features

- fully encompassing cassette that protects the cover perfectly
- tried and tested tensioning system with drive belts and integrated gas pistons – delivers optimum cover tension in any phase of extension
- with tracfix system, the continuous lateral cover guidance system that leaves no gap between the cover and guide tracks – gives improved wind stability and a cleaner appearance
- the broad range of brackets with patented clip-on system offers individual fixture solutions

Dimensions

- single unit: awning fixture width 60–450 cm in width, maximum extension 400 cm
- maximum dimensions, awning fixture width × extension: 450 cm × 400 cm
- intermediate sizes are available

Roller tube and lateral bearings

- round roller tube Ø 85 mm with keyway, galvanised steel – excellent stability, ensures near perfect cover performance even at the largest widths
- the roller tube bearing is made of stainless steel

Awning profiles

- extruded aluminium, in façade quality, powder coated
- cassette profile in two pieces, angular, height × depth 125 mm × 125 mm
- guide tracks angular, rounded edges, width × height 52 mm × 52 mm
- front profile rounded at the front, depth × height 110 mm × 52 mm

End caps

- the cassette end caps are made of die-cast aluminium, in two parts, powder coated
- the front profile end caps are made of high-quality plastic, powder coated

Fixture brackets

- extruded aluminium, powder coated
- cassette is self-supporting on guide tracks
- brackets for the guide tracks: stand-off brackets, reveal fixture, flat track brackets for lateral fixture
- standard bracket heights: 105 mm / 145 mm / 100–500 mm (bespoke heights can be ordered)
- other accessories are available

01
02
03
04
05
06
07
08
09
10
11
12
13
14
15
16
17
18
19

15

Frame colours

markilux frame colours without surcharge

traffic white, RAL 9016



metallic aluminium, RAL 9006



grey brown, similar to RAL 8019



off-white textured finish, 5233 ¹⁾



stone grey metallic, 5215 ¹⁾



anthracite metallic, 5204 ¹⁾



havana brown textured finish, 5229 ¹⁾



15

Non-standard powder-coated finish

Bespoke frame colours incur a surcharge – matt, metallic, finely textured and pearl finishes as well as other colour ranges (DB, Tiger etc.) on request. All frame colours are available at a surcharge with enhanced corrosion protection.

Colours may differ slightly from those depicted in both hue and finish.

¹⁾ textured finish

Dimensions and configuration options

Single unit

		Awning fixture width						Minimum fixture width		
		150	200	250	300	350	400	450	Hard-wired motor	Radio-controlled motor
Order dimensions		72	151	201	251	301	351	401	72	82
		150	200	250	300	350	400	450		
		+ 5,4								
H	150								107 ¹⁾	107 ¹⁾
	200									
	250									
	300									
	350									
	400									

dimensions in cm

1) = from an extension of 281 cm

H = extension

= 4 brackets

= 6 brackets

= 6 brackets,
1 cover support tube

Operation	standard	optional
crank handle	—	—
hard-wired motor	✓	—
silentec motor (optionally with an external io / RTS receiver)	—	—
radio-controlled motor io, 868 MHz	—	✓
radio-controlled motor RTS, 433 MHz	—	✓
868 MHz radio-controlled motor io with manual override	—	—

Coupled awnings

not available

Optional accessories

automatic controls (light, wind, rain)

N.B. Important background information can be found in the chapter "Optional Accessories"

Awning cover	fabric pattern no.	standard	optional
sunvas	300..-315..	✓	—
sunsilk	324.. / 325.. / 328.. / 369..	✓	—
sunbow	411..-427..	✓	—
smart art	340..	—	✓
perla FR	371.. / 372..	—	✓
perfotex	331.. / 332..	✓	—
transolair	338..	—	✓
transolair (120 cm)	339..	—	✓
vuscreen Alu	317..	—	✓
Soltis Perform 92	92-..	—	✓

Shadeplus

not available

sunvas
transolair
perla FR
 Fabric width 120 cm

Fabric pattern 301.. / 309.. – 315..
 339..
 371..³⁾ / 372..³⁾

smart art
sunsilk
 340..
 324.. / 325.. / 328.. / 369..

		Awning fixture width						
		150	200	250	300	350	400	450
AH	150							
	200							
	250							
	300							
	350							
	400							

sunvas
 Fabric pattern 31008..¹⁾, -09¹⁾, -13, -16, -18, -25, -27, -28, -31, -36, -37, -57, -58, 31109, -14, -17
 Fabric width 250 cm

		Awning fixture width						
		150	200	250	300	350	400	450
AH	150							
	200							
	243							
	300				1)	1)	1)	
	350				1)	1)	1)	
	400				1)	1)		

1) also available in fabric width 320 cm – then seamless

sunbow
 Fabric pattern 411.. - 427..
 Fabric width 120 cm

		Awning fixture width						
		150	200	250	300	350	400	450
AH	150							
	200							
	250							
	300							
	350							
	400							

Note: The maximum width of the outer panels in tracfix systems with vertical panel joints is 35 cm

= vertical panel joints (panel width approx. 120 cm)
 = seamless
 = not available
 = horizontal panel joint(s)
 AH = unit height

transolair Fabric pattern 338..
Fabric width 250 cm

		Awning fixture width						
		150	200	250	300	350	400	450
AH	150							
	200							
	243							
	300							
	350							
	400							

perfortex Fabric pattern 331.. / 332..
Fabric width 120 cm

		Awning fixture width						
		150	200	250	300	350	400	450
AH	150							
	200							
	250							
	300							
	350							
	400							

Serge 600 (not available) Fabric pattern 272..
Fabric width 250 cm

		Awning fixture width						
		150	200	250	300	350	400	450
AH	150							
	200							
	250							
	300							
	350							
	400							

Soltis Perform 92 Fabric pattern 277..
Fabric width 177 cm

		Awning fixture width						
		150	200	250	300	350	400	450
AH	150							
	180							
	250							
	300							
	350							
	400							

Note: The maximum width of the outer panels in tracfix systems with vertical panel joints is 35 cm

= vertical panel joints (panel width approx. 120 cm)
 = not available
 = seamless
 = horizontal panel joint(s)
 AH = unit height

dimensions in cm

01 **Fixtures, fittings and accessories**

02

03

04

05

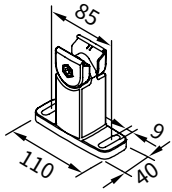

track bracket, with adjustable head

100 mm

76046.

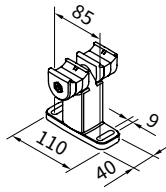

double track bracket with adjustable head 100 mm

central bracket for 2 single units next to each other

73634.

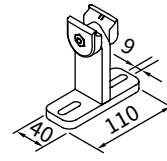

track bracket for conservatory transom fixture

100 mm

76055.

06

07

08

09

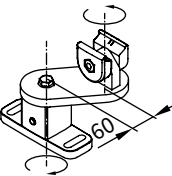

windmill track bracket

100 mm

76054.

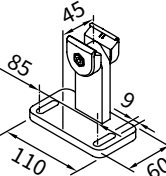

track bracket with offset footplate

100 mm

76199.

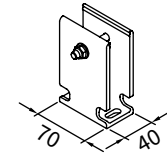

track bracket for track-only fixture, rigid

100 mm

76017.

10

11

12

13

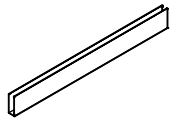

track bracket for track-only fixture, rigid by the metre, undrilled, 100 mm maximum length 6 mm

76013.

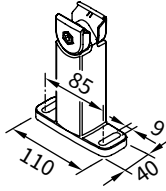

track bracket, with adjustable head 140 mm

76048.

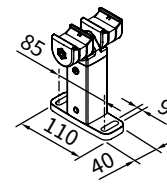

double track bracket with adjustable head 140 mm

central bracket for 2 single units next to each other

73636.

14

15

16

17

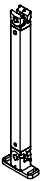

track bracket, with adjustable head and foot

200-500 mm

76045.

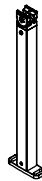

track bracket, with adjustable head

140-500 mm

76047.

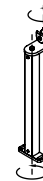

universal track bracket with adjustable head

140-500 mm

76053.

18

19

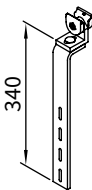

flat track bracket with adjustable head

for lateral guide track fixture

76049.

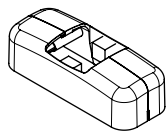

covering cap for square track bracket

standard accessory for bracket

2 x 76718.

Fixtures, fittings and accessories

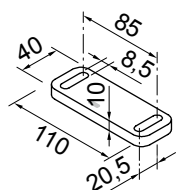

spacer plate
for track bracket
110 × 40 × 10 mm

78570.

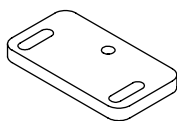

adapter plate
for track bracket
110 × 60 × 10 mm

78158.

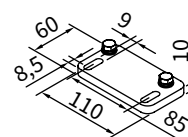

adapter plate
for track bracket
110 × 60 × 10 mm

78165.

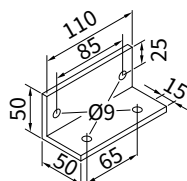

angled mounting
bracket

76098.

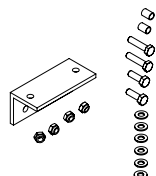

angled mounting
bracket 76098.
including coupling bolts

76099.

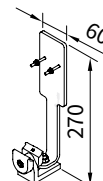

fixture bracket for light
and / or wind and/or
rain sensor

76050.

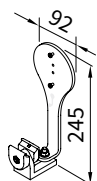

bracket for sun and/or
wind sensor io

76723.

01
02
03
04
05
06
07
08
09
10
11
12
13
14
15
16
17
18
19

15

Fixture types

21

Clearance 105 mm

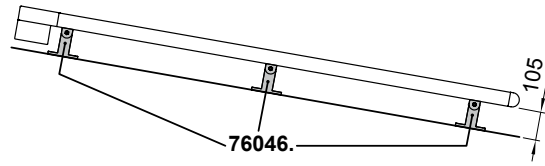

22

Clearance 145 mm

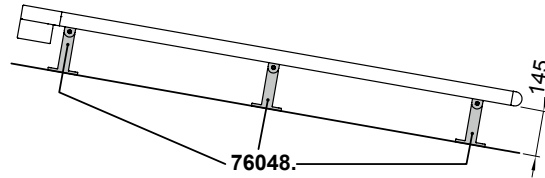

30

Flat track bracket

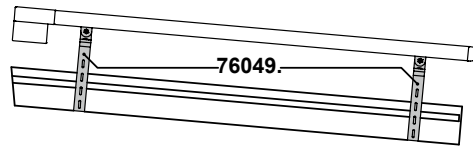

Individual bracket selection:

See "Fixtures, fittings and accessories".
Awning extension > 300 cm, always
3 brackets per guide track.

Overview of dimensions

Fixture type 21,22

Fixture type 30

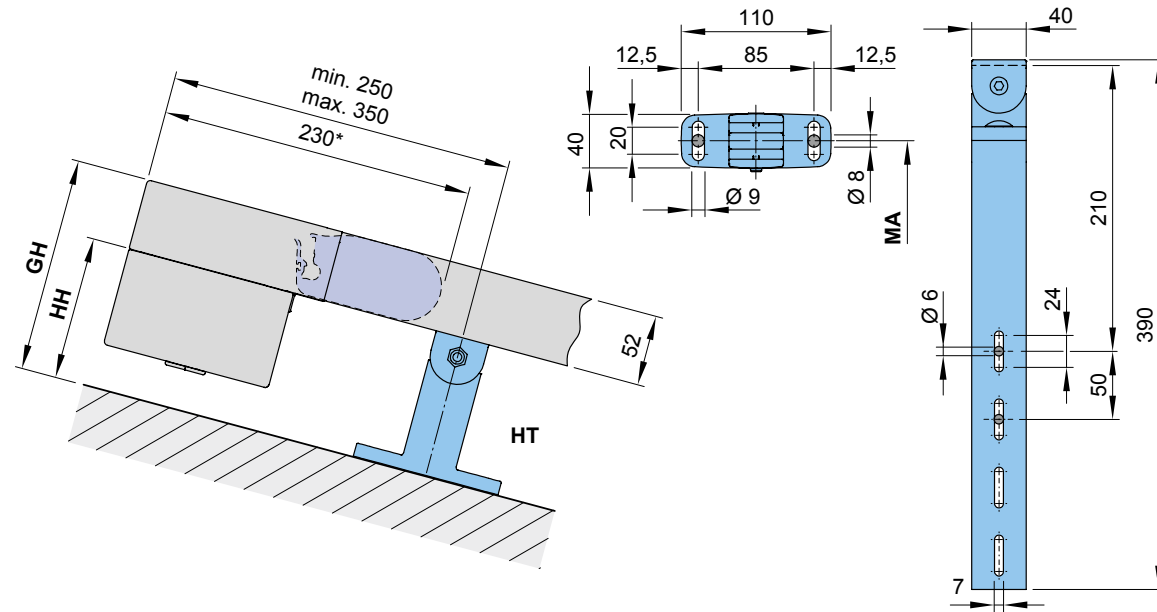

fixture type 21

fixture type 22

fixture type 30

HT	= bracket	76046.	76048.	76049.
HH	= bracket height	105	145	ca. 195–335
GH	= overall height	157	197	ca. 247–387
MA	= order dimension = blind fixture width = fixture width			
*	= extension when retracted			

dimensions in mm

Overview of dimensions

Single unit

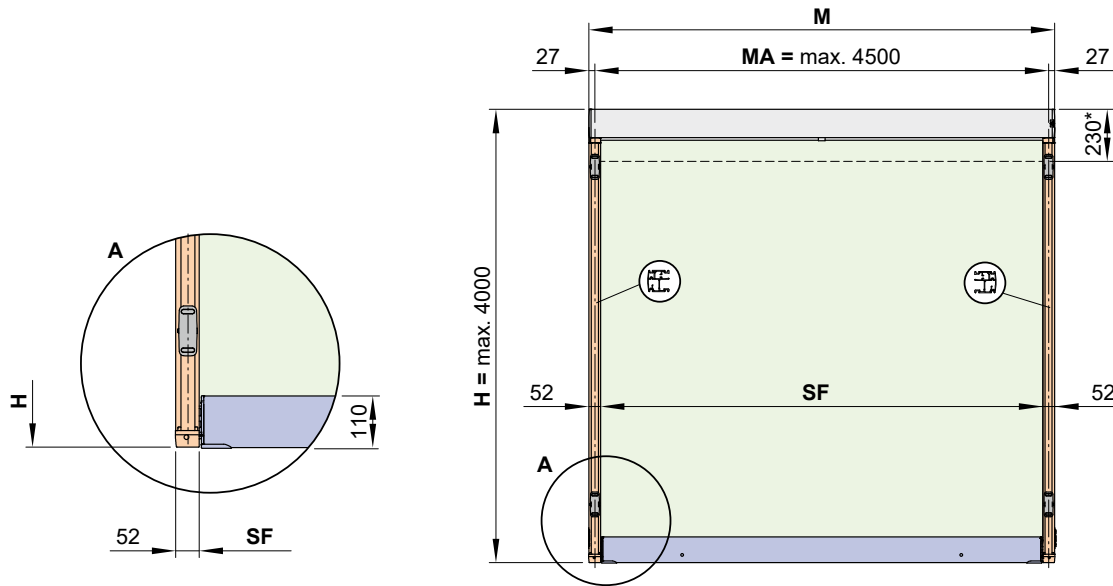

Two single units - fixture via double track brackets

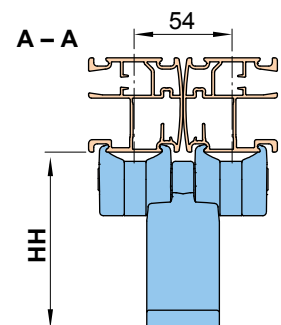
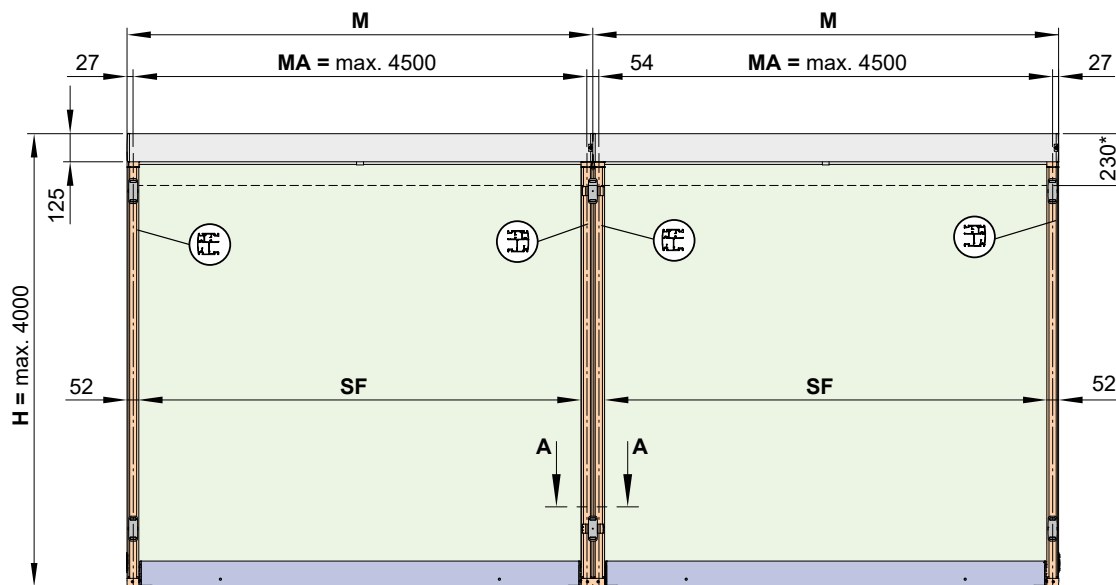

- * = extension when retracted
- H = **order dimension** = extension
- HH = bracket height
- M = awning width
- MA = **order dimension** = blind fixture width = fixture width
- SF = visible cover

dimensions in mm

01
02
03
04
05
06
07
08
09
10
11
12
13
14
15
16
17
18
19

15

01 **Dimension overview Fixture type 21, 22**

02 **Fixtures, fittings and accessories**

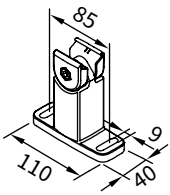

03 track bracket, with adjustable head
04 100 mm

05 **76046.**

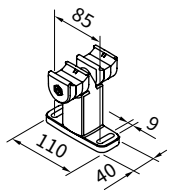

06 double track bracket with adjustable head 100 mm
07 central bracket for 2 single units next to each other

08 **73634.**

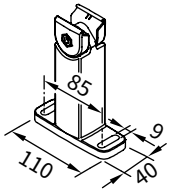

09 track bracket, with adjustable head 140 mm

10 **76048.**

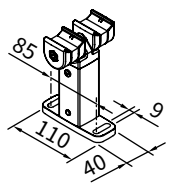

11 double track bracket with adjustable head 140 mm
12 central bracket for 2 single units next to each other

13 **73636.**

14 **15**

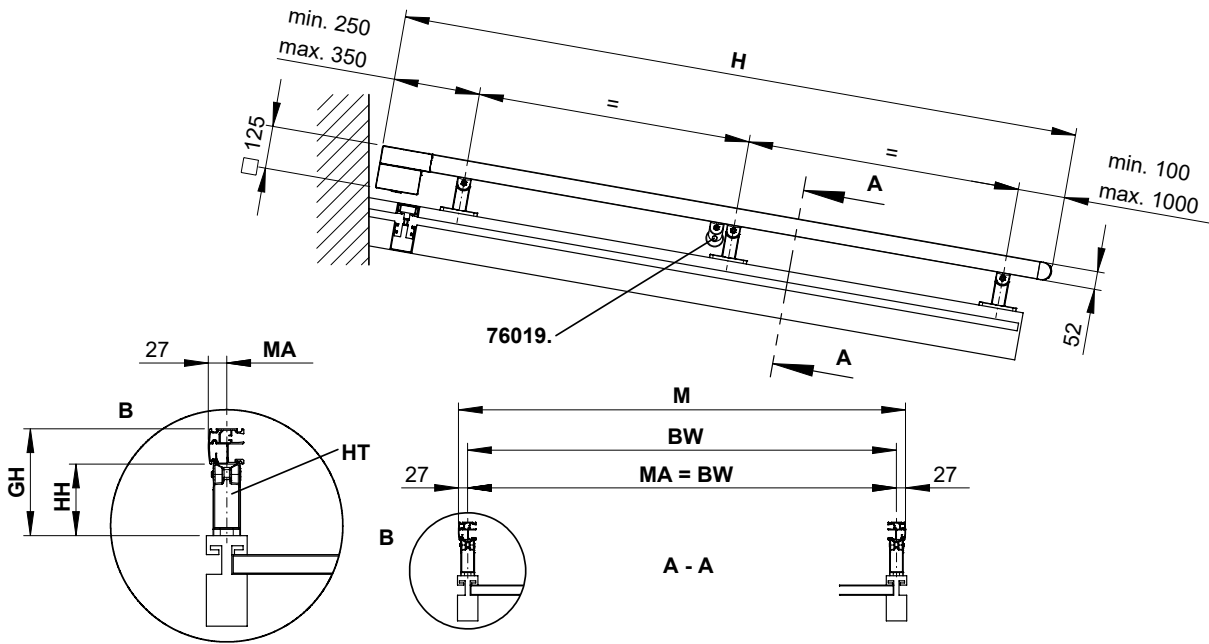

- 76019. = bracket for cover support tube
- BW = width between fixture points on the conservatory
- H = **order dimension** = extension
- HH = bracket height
- HT = bracket
- M = awning width
- MA = **order dimension** = blind fixture width = fixture width

dimensions in mm

Dimension overview fixture combination 30

Fixtures, fittings and accessories

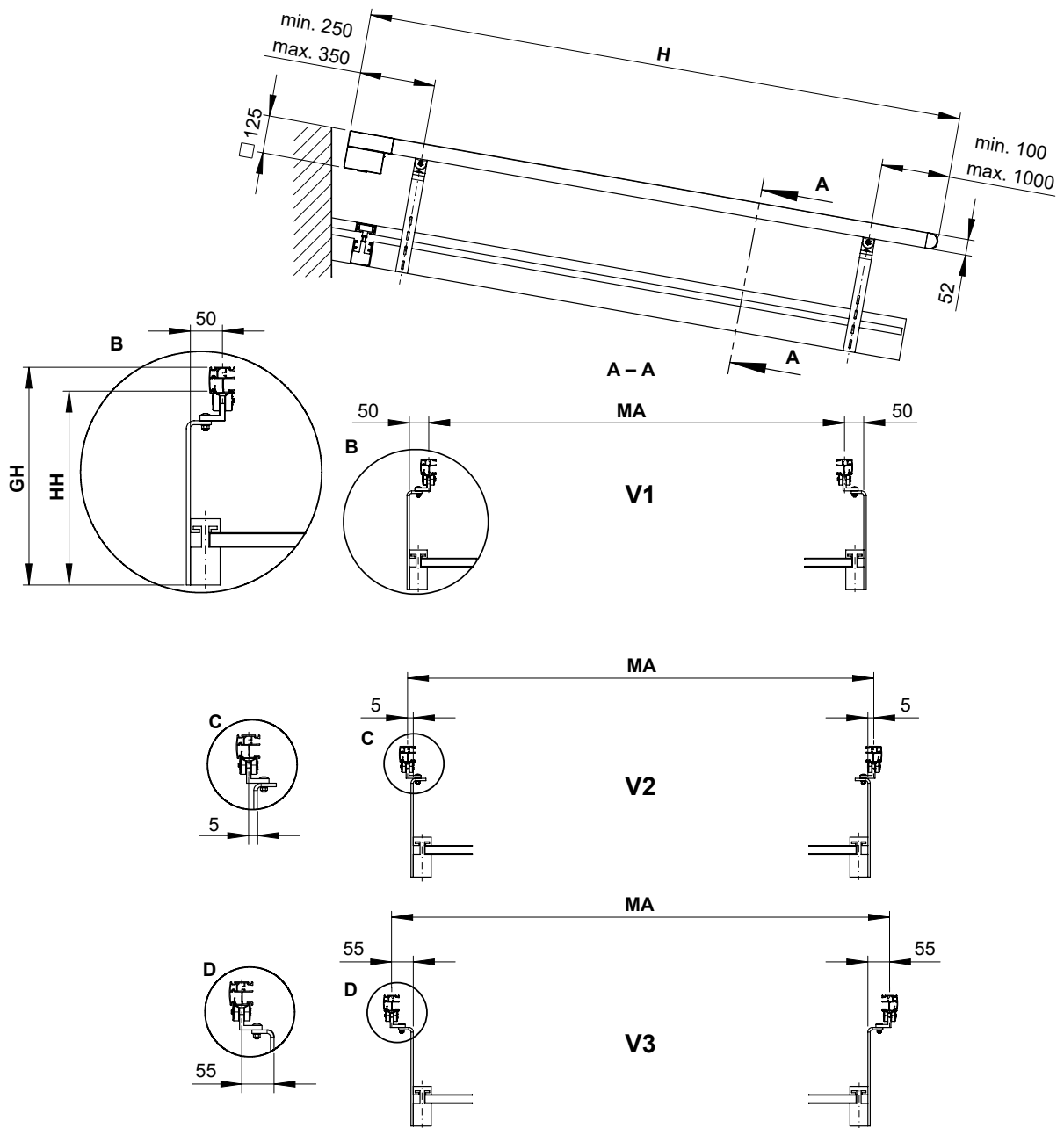
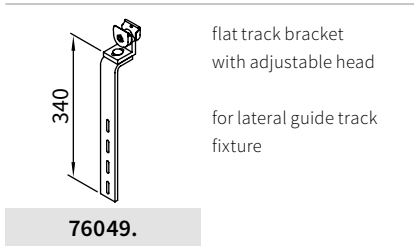

H = order dimension = extension
MA = order dimension = blind fixture width = fixture width
V1, V2, V3 = variants

dimensions in mm

01
02
03
04
05
06
07
08
09
10
11
12
13
14
15
16
17
18
19

Dimension overview eaves fixture with additional bracket fitting

Fixtures, fittings and accessories

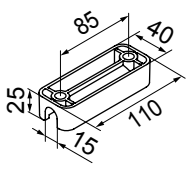

track bracket accessory
width 14 mm
for direct assembly on
conservatory rafters

76804.

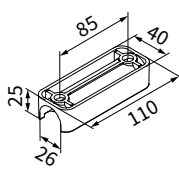

track bracket accessory
width 25 mm
for direct assembly on
conservatory rafters

76805.

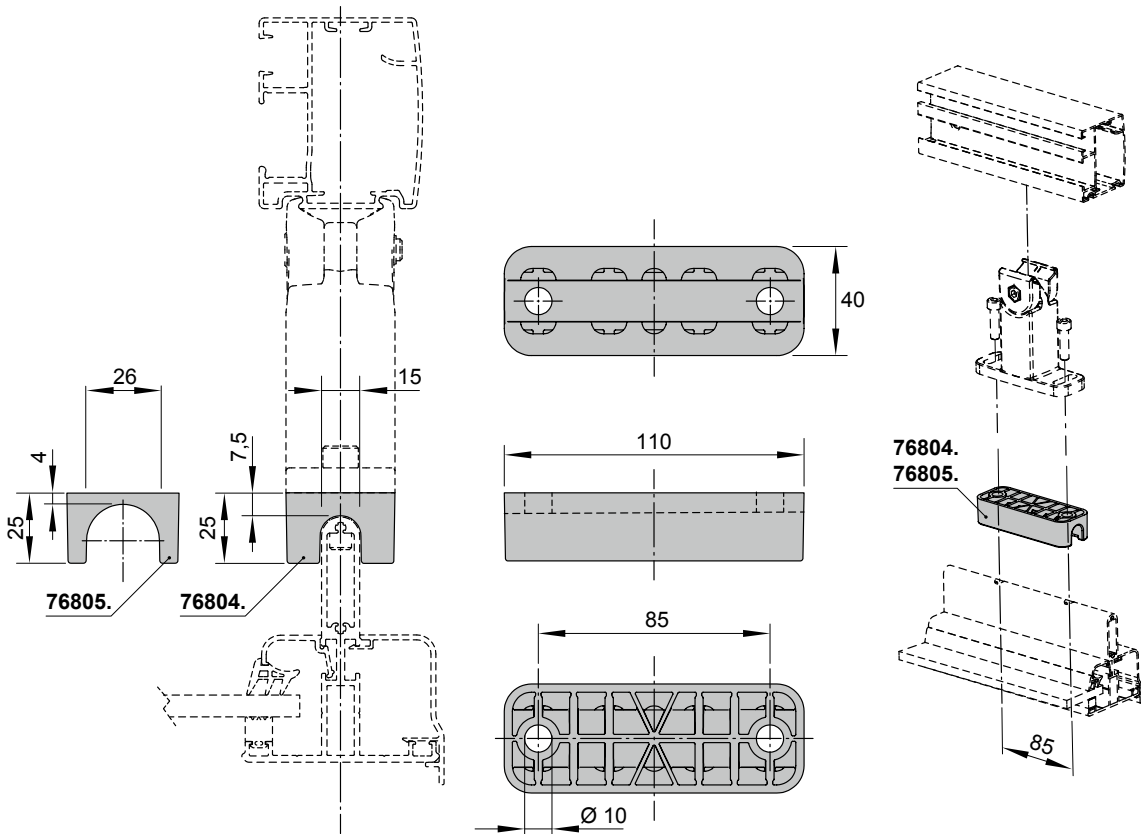

15

Motor cable exit point

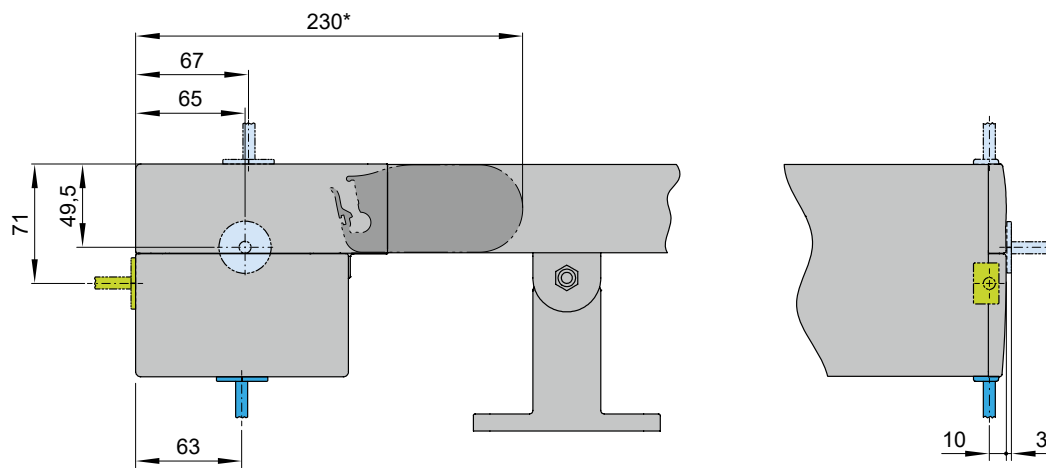

- 01
- 02
- 03
- 04
- 05
- 06
- 07
- 08
- 09
- 10
- 11
- 12
- 13
- 14
- 15**
- 16
- 17
- 18
- 19

- * = extension when retracted
- = standard
- = optional
- = optionally with surcharge

dimensions in mm

01

02

03

04

05

06

07

08

09

10

11

12

13

14

15

16

17

18

19